

HOLIDAY

HK KITCHENS
select

DOOR BROCHURE
& STYLE GUIDE



HK *select*



For over 75 years Holiday Kitchens has been part of the Rice Lake, WI community and proudly making cabinets in the USA.



Holiday Kitchens is dedicated to excellence with your complete satisfaction in mind. Holiday Kitchens Select offers a Limited Lifetime Warranty on cabinetry, in addition to a Limited Warranty backed by the manufacture on the drawer guides, hinges, and many of the accessory items, giving you confidence that you chose the right cabinet line.

SPECIES AND FINISH OPTIONS

Stain

Maple

Alder/Rustic Alder

Oak/Rustic Oak

Ash



Java

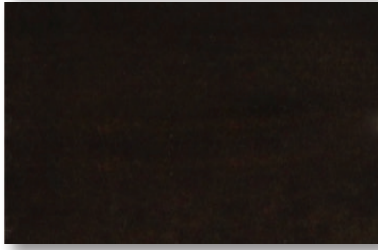

Natural

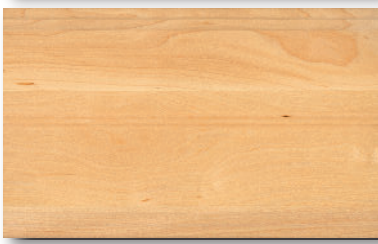

Oyster

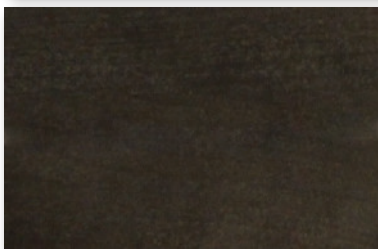

Umber

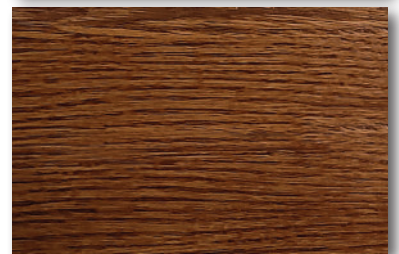
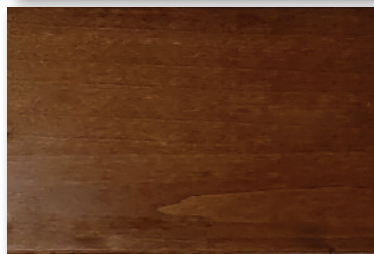
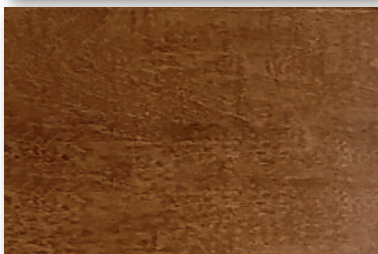

Paint

White

Ice White

Vanilla

Moss

Gray

Black

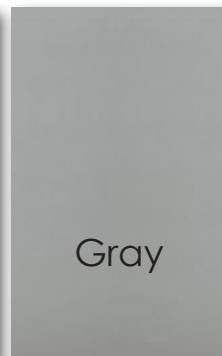
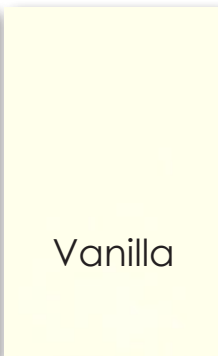
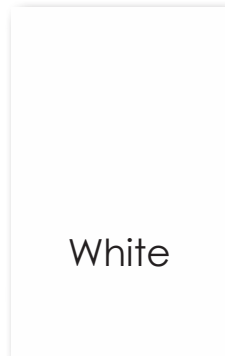

DOORS

Wood Doors - available in Framed and Frameless

FLAT PANEL DOORS



Beck, Paint Grade MDF in Vanilla
Edge Profile: Custom
Maple, Oak, and Paint Grade MDF



Charleston, Oak in Umber
Edge Profile: 125
Maple, Oak, and Paint Grade MDF



Madison, Rustic Alder in Ash
Edge Profile: 600
Alder, Rustic Alder, Maple, Oak,
Rustic Oak, and Paint Grade MDF



Mission, Paint Grade MDF in White
Edge Profile: 600
Alder, Rustic Alder, Maple, Oak, Rus-
tic Oak, Paint Grade MDF

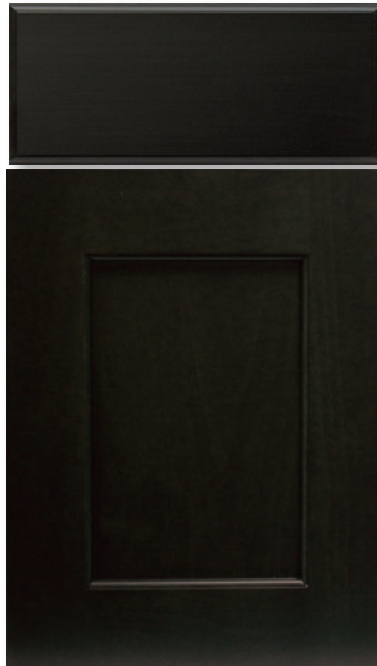

Phoenix, Paint Grade MDF in Black
Edge Profile: 600
Alder, Rustic Alder, Maple, Oak,
Rustic Oak, Paint Grade MDF



Quincy Paint Grade MDF in Ice
White
Edge Profile: 600
Alder, Rustic Alder, Maple, Oak,
Rustic Oak, Paint Grade MDF

DOORS

Wood Doors (cont.) - available in Framed and Frameless

RAISED PANEL DOOR



Lancaster Square, Paint Grade MDF in Gray
Edge Profile: 650
Alder, Rustic Alder, Maple, Oak,
Rustic Oak, and Paint Grade MDF

SLAB DOOR



Champlain, Maple in Natural
Edge Profile: 125
Alder, Maple, Oak, Paint Grade MDF



DOORS



Maintenance Free Doors - *available in Framed and Frameless*

MAINTENANCE FREE DOORS

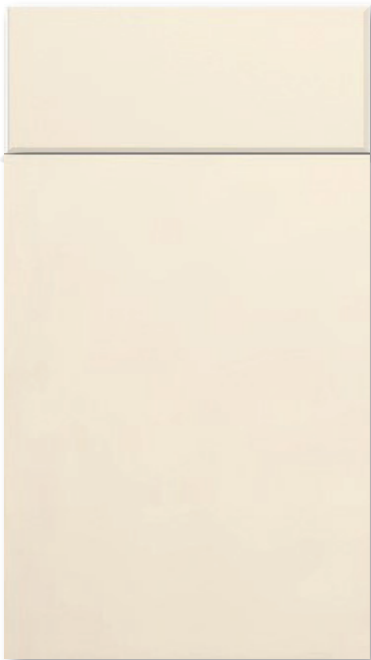

Elegante, Thermofoil in Vanilla
slab door

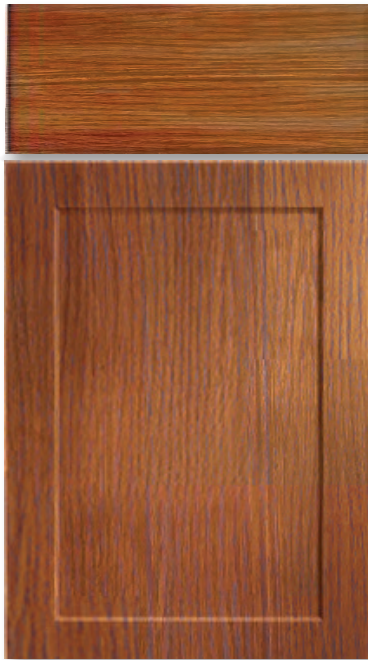

Shaker, Thermofoil in Umber
flat panel door



Classic, Thermofoil in Ice White
raised panel door

GENEVA TFL

The Geneva TFL line is only available in HK Select Frameless. This Thermally Fused Laminate is easy to maintain and with normal use and basic maintenance, will last long into the future. The six colors were hand selected based on popular styles from the Custom Holiday Kitchens Line. The wood grain and matching banding, combined with the Geneva Door will create a beautiful, sophisticated look for any cabinet project.



After Hours



Après

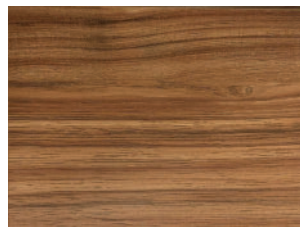

Brass Band

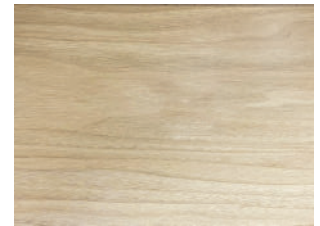

Casting at First Light

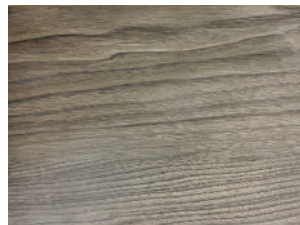

Sunset Cruise

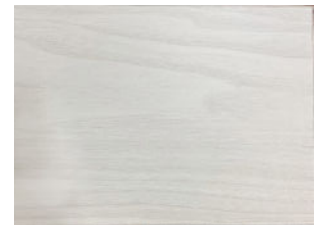

Winter Fun



This photo is for demonstration purposes only. The Geneva TFL line will allow all HK Select options.

CONSTRUCTION

Framed

A. Interior Housing: Champagne vinyl for stained or white vinyl for painted 1/2" plywood sides, 1/2" particle board top (wall) and bottom (wall bottoms match cabinet interior)

B. Back: 1/2" plywood – fully captive

C. Cabinet Side: 1/2" plywood with 1/8" exterior lip. Front to back stretcher fully captive.

D. Drawer Box: 5/8" hardwood box with side mounted epoxy coated drawer guides

E. Shelves: Full depth, adjustable 3/4" particle board 2-sided vinyl with PVC banding.

F. Face Frame: 3/4" x 1 1/2" solid hardwood

G. Toe Board: 1/4" material shipped loose (8 ft. pieces) for field installation. Toe kick height is 3 1/2"

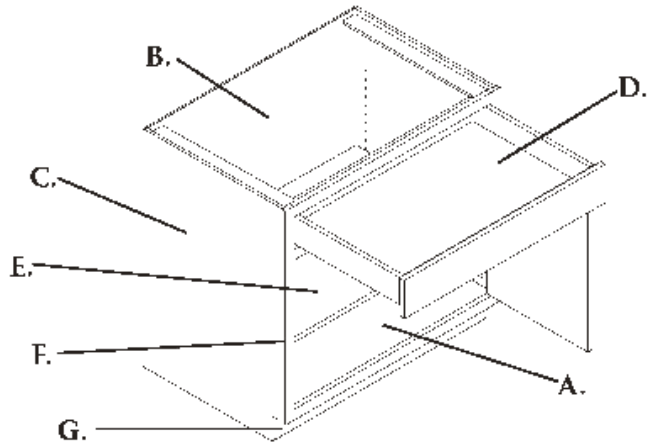

Frameless

A. Interior Housing: Wood Stained and TFL door orders have Maple Melamine interior. Wood Painted and Maintenance Free Foil door orders will have white melamine interior.

B. Back: 1/4" thick and are glued into grooves in the sides, tops and bottom. 2 13/16" wide x 1/2" thick integrated hanger strips

C. Cabinet Side: 3/4" thick premium industrial particle board sides, tops and bottoms. 8mm wood dowels glued in place hold tops and bottoms between sides.

D. Drawer Box: 5/8" hardwood box with Quadro drawer guides

E. Shelves: Adjustable 3/4" particle board 2-sided vinyl with PVC banding.

F. Toe Board: 3/4" material shipped loose (8 ft. pieces) for field installation. Toe kick height is 4 1/2".

G. Banding – Matching PVC

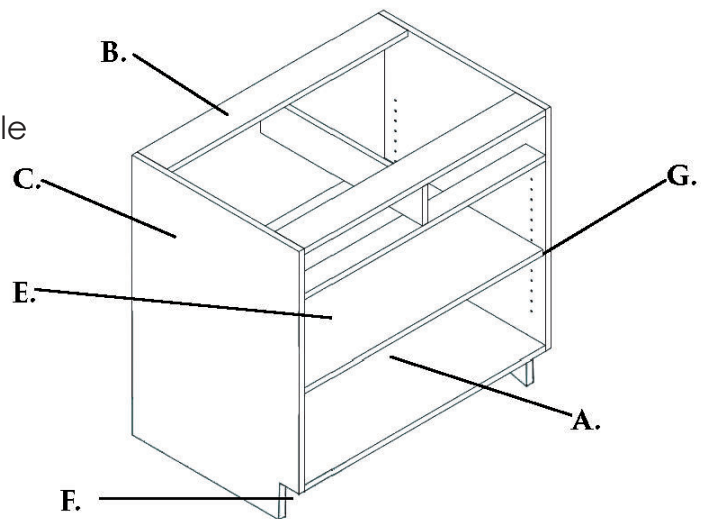

OUR COMMITMENT

Since HK Select has launched, Holiday Kitchens has committed to developing this line, maintaining the simplicity and sophistications of its selections. And to always be the 'go-to' line for Builders.

HK Select:

1. Competitively Priced
2. Limited Selections with available upgrades
3. Quality Standards that match the Holiday Kitchens Custom Line
4. Easy to place an order with 2020 Catalogs and HKOE
5. Comprehensive Product Catalogs for both Framed and Frameless
6. Offers 'must have' design elements, such as route for glass, decorative island legs, and more!
7. Limited Lifetime Warranty



GALLERY



HOLIDAY **HK** KITCHENS
select



A Division of Mastercraft Industries
120 West Allen
Rice Lake, WI 54868

715-736-9200
www.holidaykitchens.com
2022

